

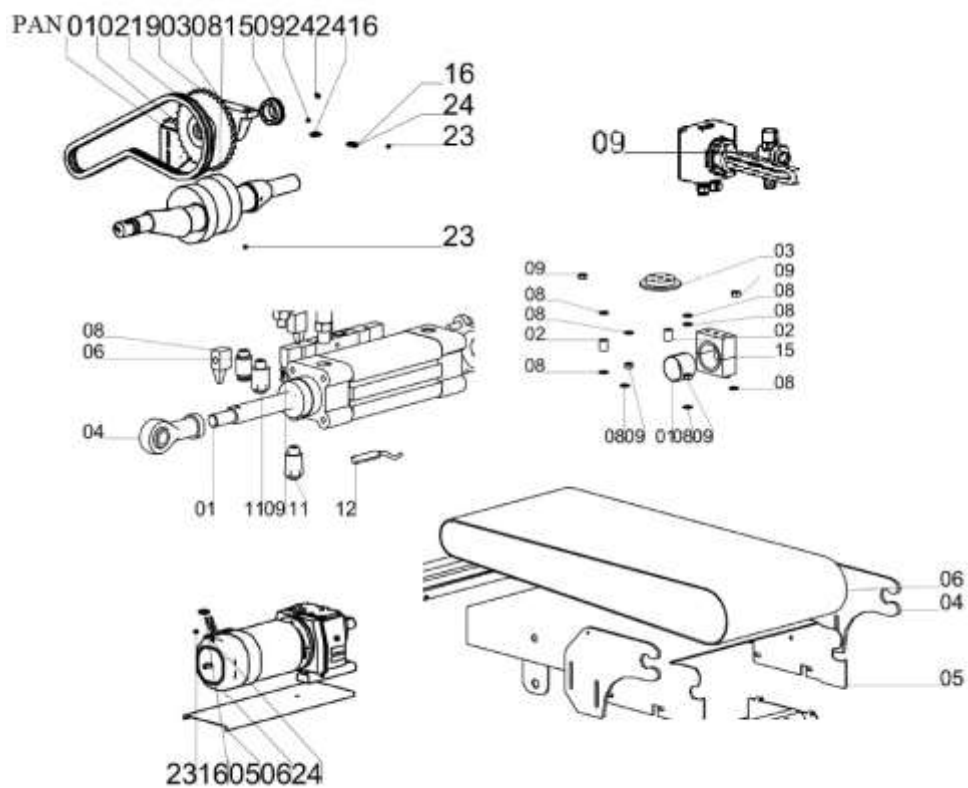

CATALOG PIESE DE SCHIMB



NECESARE PERFORMANTEI ECHIPAMENTELOR DUMNEAVOASTRA

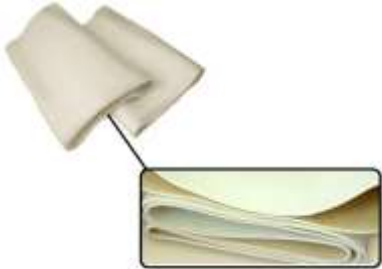

Denumire	Aplicatii	Cod	Imagine
BANDA TRANSPORT INOX	Masini ciocolata/Universal	PAN01INOX	
BANDA TRANSPORT PLASTIFIATA	Universala Se Comanda In Functie De Echipament, La Dimensiunea Dorita. Banda Poate Aave Imbinari Lipite(In Cazul In Care Echipamentul Este Dotat Cu Razuitor) Sau Fermoar. La Alegere, Se Pot Comanda Benzi De Tip „Napolitana” , Lisa,Etc.	PAN01PLA	
BANDA TRANSPORTOARE PASLA	Universala	PAN01PAS	

Denumire	Aplicatii	Cod	Imagine
AUTOMAT APRINDERE INJECTOR GAZ	Gb Ganz	PAN.GBAG01	
AUTOMAT APRINDERE INJECTOR MOTORINA	Gb Ganz	PAN.GBAM01	
AUTOMAT APRINDERE	Injector Gaz Riello	PAN.RLLAG02	
BEC ILUMINAT	Logiudice Danzi Termopan	PAN.Bi01 PAN.Bi02 PAN.Bi03	

Denumire	Aplicatii	Cod	Imagine
CUTIE ASPIRATIE	GB GANZ	PAN.CA01	
DEFLECTOR GAZ	Injector Gaz GB GANZ	PAN.DG01	
DUZA GAZ	Injector Gaz GB GANZ	PAN.DuG01	
ELECTROVALVA	Cuptor DANZI Dospitoare PAN ADAMI	PAN.ELV01	

Denumire	Aplicatii	Cod	Imagine
ELECTROVALVA ½” 24V	Cuptor Logiudice /Universal	PAN.ELV02	
FOLIE PENTRU PANOU DIGITAL CUPTOR ROTATIV	Cuptor Rotativ Logiudice	PAN.FPD01	
FOLIE PLASTIC PANOU COMANDA	Cuptor Rotativ Logiudice	PAN.FPC01	
FOLIE PLASTIC PANOU COMANDA	Cuptor Rotativ Logiudice	PAN.FPC02	

Denumire	Aplicatii	Cod	Imagine
FURTUN TERMOREZISTENT	Universal	PAN.FTR01	
GARNITURI CAUCIUC	Cuptor Rotativ 50*70/60*80/80*120 Logiudice	PAN.GC5070 PAN.GC6080 PAN.GC80120	
GARNITURA USA	Logiudice	PAN.GU01	
GARNITURA USA	Polin Zucchelli/	PAN.GU02 PAN.GU03	

Denumire	Aplicatii	Cod	Imagine
GARNITURA USA/GEAM	Cuptor Termopan	PAN.GU04	
MELC HOTA CU MOTOR FARA MOTOR	Cuptor tuburi amulare/Rotativ Logiudice	PAN.MH01 PAN.MH02	
MOTOR ROTIRE CARUCIOR	Cuptor Rotativ Logiudice	PAN.MRC01	
MODUL DE SIGURANTA 24V/220V	Cuptor Ciclotermic Termopan	PAN.MS24V PAN.MS220V	

Denumire	Aplicatii	Cod	Imagine
MODLUL RELEE	Cuptor Ciclotermic Termopan	PAN.MR01	
MOTOR PENTRU DISPOZITIV AUTOMAT DE DESCHIDERE TUFECURI	Cuptor Ciclotermic Termopan	PAN.MT01	
PANOU COMANDA	Cuptor Ciclotermic Termopan	PAN.PCOM01	
PLACA ELECTRONICA	Cuptor Ciclotermic Termopan	PAN.PELT01	



Denumire	Aplicatii	Cod	Imagine
PRESOSTAT	Cuptor Ciclotermic Termopan	PAN.TERPR01	
PRESOSTAT AER	Gb Ganz	PAN.GBPrA	
PERIE CUPTOR	Universal	PAN.PCV01	
PERIE CUPTOR	Universal	PAN.PCV02	

Denumire	Aplicatii	Cod	Imagine
PLACA DE BAZA CU AFISAJ	Cuptor Rotativ Logiudice	PAN.TKNPELA01	
RAMPA ELECTROVALVE	Cuptor Ciclotermic Termopan	PAN.TERELV01	
REZISTENTA CUPTOR ELECTRIC	Logiudice	PAN.TKNRZCE01	
REZISTENTA VARIABILA (Abur)	Termopan	PAN.TERVAR01	

Denumire	Aplicatii	Cod	Imagine
SONERIE	Cuptor Ciclotermic Termopan	PAN.TERBUZ01	
SONERIE	Cuptor Logiudice	PAN.TEKBUZ01	
POMPA MOTORINA	Gb Ganz	PAN.GBSPGz01	
STICLA PROTECTIE BEC	Logiudice LF	PAN.TEKSpB01	

Denumire	Aplicatii	Cod	Imagine
SONDA TEMPERATURA HORN	Cuptor Ciclotermic Termopan	PAN.TERSTH01	
SONDA TEMPERATURA	Cuptor Ciclotermic Termopan/ Universal	PANTERST01	
SERVOMOTOR 230V	Cuptor Ciclotermic Termopan/ Universal	PAN.SRVMT01	
SERVOMOTOR MOTOR CARUCIOR	Cuptor Rotativ Logiudice/Zucchelli	PAN.TEKSVM PAN.ZUCSRVM	

Denumire	Aplicatii	Cod	Imagine
STICLA PROTECTIE BEC	Danzi	PAN.DANSpB01	
SNUR STICLA	Universal	PAN.SNST01	
PANOU COMANDA	Universal	PAN.PCOM01	
TERMOSTAT DIGITAL	Cuptor Rotativ Logiudice	PAN.TDTK72	

Denumire	Aplicatii	Cod	Imagine
TIJA IONIZARE	GB GANZ	PAN.GBTI01	
TRANSFORMATOR	WERNER & PLFEIDERER	PAN.WPTRA01	
TUB FLACARA	Injector GB GANZ	PAN.GBTF01	
VATRA CUPTOR 620*2800*20	UNIVERSAL (Se poate debita in functie de camera de coacere a cuptorului)	PAN.Va-L*I L=lungime; I=latime;	

Denumire	Aplicatii	Cod	Imagine
GEAM CUPTOR	Cuptor Logiudice/Danzi	PAN.TKNGC01 PAN.DANGC01	N/A
VATA MINERALA	Universal	PAN.VMIN	N/A
TUB PENTRU ASPIRATOR	Universal	PAN.TUBAØ	N/A
FURTUN ASPIRATOR	WP - OBER	PAN.WPFAS01	N/A

Denumire	Aplicatii	Cod	Imagine
AX BANDA	Bertuetti	PAN.BERAX01	
CEAS REGLARE GRAMAJ	Bertuetti	PAN.BERCRG01	
CUREA TRANSMISIE	Mapanva	PAN.MPVCT01	
FILTRU ULEI	Bertuetti	PAN.BER.FUL01	

Denumire	Aplicatii	Cod	Imagine
FULIE DUBLA	Bertuetti	PAN.BERFDB01	
FURTUN SILICONIC	Universal	PAN.FSI01	
LAGAR	Wp Haton /Universal	PAN.WPHLAG01	
PINION	Pabialpa / Universal	PAN.BERPIN01	





Denumire	Aplicatii	Cod	Imagine
POMPA ULEI	Bertuetti	PAN.BER.PUL01	
POMPA ULEI	Divizor Pabialpa	PAN.PABPUL01	
POMPA ULEI	Divizor Mapanva	PAN.MPVPUL01	
POMPA ULEI	Wp Haton	PAN.WPHPUL01	

Denumire	Aplicatii	Cod	Imagine
PISTON MASINA DIVIZAT	PABIALPA P120÷160	PAN.PABPD120...	
REDUCTOR BANDA	Divizor Pabialpa (Banda)	PAN.PABRED01	
ROATA DINTATA DUBLA	Divizor BERTUETTI	PAN.BERRDB01	
ROATA DINTATA PLASTIC	Divizor	PAN.DIVRDB01	

Denumire	Aplicatii	Cod	Imagine
SET GERNITURI PISTON	Divizor Mapanva	PAN.MPVSG80÷140	
SET GARNITURI PISTON	Pabialpa	PAN.PABSG120 PAN.PABSG135 PAN.PABSG160	
STIFT SIGURANTA	Divizor WP Haton	PAN.WPHSTS01	
ARTICULATIE SFERICA	Bertuetti	PAN.BERASF01	N/A
POTENTIOMETRU	Pabialpa	PAN.PABPOT01	N/A

Denumire	Aplicatii	Cod	Imagine
ELICE VENTILATOR	Dospitor Zucchelli	PAN.ZUTRVN01	
ELECTROVALVA	Dospitor Atrpan/Pan Adami	PAN.PAELV01	
LAMPA	Universal	PAN.PALAM01	
MOTOR INSTALATIE CONDITIONARE	Atrepan	PAN.ATRMIC01	

Denumire	Aplicatii	Cod	Imagine
MOTOR INSTALATIE CONDITIONARE	Atrepam	PAN.ZUCMIC01	
REZERVOR APA CU ELECTROD	Dospitor Thermobake	PAN.TBKRAE01	
REZISTENTA CALDURA 1000W	Dospitor Pan Adami	PAN.PAREC1000	
REZISTENTA CALDURA 600W	Dospitor Pan Adami	PAN.PAREC600	

Denumire	Aplicatii	Cod	Imagine
REZISTENTA UMIDITATE	Baie de oparire	PAN.PAREGA01	
REZISTENTA M	Caldura/Umiditate Dospitor Atrepan	PAN.ATRREM01	
REZISTENTA M CURBATA	Dospitor Atrepan	PAN.ATRREMC01	
REZISTENTA CALDURA	Universal	PAN.UNVREC01	

Denumire	Aplicatii	Cod	Imagine
REZISTENTA CALDURA	Universal	PAN.UNVREC02	
REZISTENTA CALDURA	Universal	PAN.UNVREC03	
REZISTENTA UMIDITATE	Umiditate Dospitor Pan Adami	PAN.PAREUM01	
GARNITURA USA	Dospitor Pan Adami	PAN.PAGU01	

Denumire	Aplicatii	Cod	Imagine
SONDA UMIDITATE	Universal	PAN.UNVSUM01	
SONDA TEMPERATURA	Universal	PAN.UNVST01	
UMIDOMETRU	Dospitor Atrepan/Pan Adami/Universal	PAN.CUMID01	
UMIDOMETRU	Universal	PAN.UNVUMID01	

Denumire	Aplicatii	Cod	Imagine
TERMOSTAT TEMPERATURA	Dospitor Atrepan/Pan Adami/Universal	PAN.CTEMP01	
TERMOSTAT PROTECTIE	Vaporizator Atrepan	PAN.ATRTERP01	
AUTOCOLANT	Dospitor Pan Adami	PAN.PAACL01	
VENTILATOR DE TUBULATURA	Dospitor Pan Adami	PAN.PAVTB01	

Denumire	Aplicatii	Cod	Imagine
CITITOR IMPULSURI	Dozator Apa Turri Alaska	PAN.ABMCI01	
CITITOR IMPULSURI	Dozator Apa Turri Alaska	PAN.ABMCI02	
FOLIE COMENZI	Dozator Apa Turri Alaska	PAN.ABMFC01	
PLACA DE BAZA	Dozator Apa Turri Alaska	PAN.ABMPB01	

Denumire	Aplicatii	Cod	Imagine
SONDA TEMPERATURA	Dozator Apa Turri Alaska	PAN.ABMST01	
CARCASA	Dozator Apa Turri Alaska	PAN.ABMCAR01	
BUTON REGLARE	Dozator Apa Turri Alaska	PAN.ABMBUT01	
FURTUN APA	Dozator Apa Turri Alaska	PAN.ABMFUA01	N/A

Denumire	Aplicatii	Cod	Imagine
TIMER CDC TY92	Malaxoare MIXER	PAN.MIXTY92	
TIMER MULTICROM	Malaxoare MIXER	PAN.MIXMC72	
TIMER DUBLU	Malaxoare MECNOSUD	PAN.MECTD01	
ROLE GHIDAJ CUVA	Malaxoare MIXER	PAN.MIXRGC01	

Denumire	Aplicatii	Cod	Imagine
ROATA FRICTIUNE	Angrenaj Cuva	PAN.MIXRFR01 PAN.BERRFR01	
SET RULMENTI	Mecnosud Seria SP	PAN.MECSP60÷250	
CAPAC MALAXOR	Kemper (Eco)	PAN.KEMCM01	
CARLIG CUVA EXTRACTIBILA	Mixer	PAN.MIXCCEX01	

Denumire	Aplicatii	Cod	Imagine
BARA TRANSVERSALA LONGITUDINALA	ITALDIBIPACK	PAN.IDPKBT01 PAN.IDPKBL01	
CAPAC MASINA	ITALDIBIPACK	PAN.IDPKCM01	
CARBUNE REZISTENTA	ITALDIBIPACK	PAN.IDPKCRE01	
COLTAR LAMA LIPIRE	ITALDIBIPACK	PAN.IDPKCOL01	

Denumire	Aplicatii	Cod	Imagine
ELECTROMAGNET	ITALDIBIPACK	PAN.IDPKEMG01	
LAMA LIPIRE	ITALDIBIPACK	PAN.IDPKLAL01	
PANOU COMANDA	ITALDIBIPACK	PAN.IDPKPCOM01	
PISTON CU GAZ	ITALDIIPACK (Capac)	PAN.IDPKPGAZ01	

Denumire	Aplicatii	Cod	Imagine
RACLET	DELFIN	PAN.DLFRAC01	
RACLET	DELFIN	PAN.DLFRAC02	
REZISTENTA	ITALDIBIPACK	PAN.ITDBKREZ01	
REZISTENTA		PAN.DLFREZ02	

Denumire	Aplicatii	Cod	Imagine
ROLA TUS DATIERA	Universal	PAN.UNVRTD01	
ROLA CLIPS	Universal	PAN.UNVROLC01	
ROLA CU BANDA TUSATA- Imprimare data clips	Universal	PAN.UNVRTUS01	
SARMA LIPIRE	Universal	PAN.UNVSRL01	

Denumire	Aplicatii	Cod	Imagine
SPRAY SILICON	Italdibipack	PAN.IDPKSSI01	
SUPPORT RACLET	Delfin	PAN.DLFSRAC01	
CUTIT TAIERE	Delfin	PAN.DLFCUT01	N/A
CONTRA CUTIT	Delfin	PAN.DLFCCT01	N/A

Denumire	Aplicatii	Cod	Imagine
ARC MANER	Masina Feliat Jac/Universal	PAN.JACARC01	
BIELA	Masina Feliat Jac	PAN.JACBIE01	
CUTITE	Masina Feliat Jac	PAN.JACCUT01	
CUTITE	Universal (Se comanda dupa distanta intre bolturi/gauri)	PAN.UNVCUT01	

Denumire	Aplicatii	Cod	Imagine
CUTIT FELIATON	Domina	PAN.FISCUT01	
LAMELA FELIATOR	JAC	PAN.JACLAM01	

Denumire	Aplicatii	Cod	Imagine
SENZOR FOTOELECTRIC	Masini de turat	PAN.UNVSFOT01	
TERMOSTAT	Cuocicrema	PAN.UNVTERM01	
OCHI DE PISICA	Universal	PAN.UNVOP01	
TIMER MECANIC	Universal	PAN.UNVTMEC01	

Denumire	Aplicatii	Cod	Imagine
BUTON	Universal (Se comanda in functie de necesitati-urgenta/selector /general	PAN.UNVBUT01	
CONTROLLOR UMIDITATE.TEMPERATURA	Universal	PAN.UNVCUMT01	
CONVERTIZOR FRECVENTA	Universal	PAN.UNVCFRV01	
CUREA TRANSMISIE	Universal	PAN.UNVCTR01	

Denumire	Aplicatii	Cod	Imagine
CONTACTORI , RELEE	Universal	PAN.UNVELECT01	
LANT TRANSMISIE	Universal	PAN.UNVLTR01	
LIMITATORI	Universal	PAN.UNVLIM01	
PISTON GAZ	Universal	PAN.UNVPGZ01	

Denumire	Aplicatii	Cod	Imagine
REDUCTOR	Universal	PAN.UNVRED01	
ROATA CARUCIOR	Universal	PAN.UNVROC01	
ROATA CU FRANA	Universal	PAN.UNVROFR01	
ROATA TERMOREZISTENTA	Universal	PAN.UNVROTR01	

Denumire	Aplicatii	Cod	Imagine
RULMENTI	Universa	PAN.UNVRUL...	
PISTON USA	Universal	PAN.UNVPIB01	
SIMERING	Universal	PAN.UNVSIM...	
TERMOSTAT	Baie oparire Pan Adami / Universal	PAN.UNVTERM01	

Denumire	Aplicatii	Cod	Imagine
TIMER + SOCLU	Universal	PAN.UNVTIM01	
INSTALATIE ELECTRICA	Universal /Dospitor Pan Adami	PAN.PAINEL...	
REZISTENTA INCALZIRE APA	Masina De Spalat Meiko/Universal	PAN.UNVREH20	
MAGNET TUBULATURA	Cernator	PAN.PAMAGT01	

Cuprins

Benzi transportoare	2
Cuptoare	3
Divizoare	16
Dospitoare	21
Dozator Apa	27
Malaxoare.....	29
Masini de ambalat	31
Masini de feliat.....	36
Masini de fursecuri.....	38
Universal	39